

GT PUSH, 2 INSULATED BOWLS AND ELECTRONICAL CONTROL



GT PUSH, 2 INSULATED BOWLS AND
ELECTRONICAL CONTROL

**Ref: 561011
(GT2P)**

GT PUSH 2 STD 230/50 BLACK - GAS R290

General Features

GT PUSH is a compact, multi-purpose unit, that dispenses soft serve, cold creams, sherbets, frozen yogurt and granitas.

Elegant design and compact dimensions combined with the excellent price-quality ratio make GT PUSH an ideal tool for all Ho.Re.Ca operators.

The GT PUSH 2 is equipped with n. 2 I-Tank insulated bowls, 5 litres each. The I-Tank insulated bows reduces the impact of the external temperature on the product, improving the cooling efficiency of the equipment, and saving energy and money.

The intuitive front keyboard allows you to adjust the temperature, and the PUSH button increases the motor speed for a quicker dispensing of the product.

Tanks work independently.

GT PUSH works with water- or milk-based powder products or with ready-to-use mixes to pour directly into the bowls, and guarantees high overrun which means a high return on investment.

GT PUSH comes in black or white plastics with stainless steel finish.

SPM

GT PUSH, 2 INSULATED BOWLS AND ELECTRONICAL CONTROL

Specifications

- Safety stop system.
- Lockable lid
- High overrun
- It is possible to customize the graphics on the lid and on the back (subject to negotiation).
- Compact countertop machine for dispensing soft serve ice cream, frozen yogurt, cold creams, granitas and sorbets.
- This equipment works with water- or milk-based powder products or with ready-to-use mixes to pour directly into the bowl.

Construction

- The patented I-Tank insulated bowl reduces the impact of ambient temperature on the product, improving its cooling efficiency and guaranteeing energy and cost savings.
- Electronic keyboard for temperature regulation.
- The “PUSH” button increases motor speed, allowing to quickly extract the product.
- Bowls work independently, and thanks to this is it possible to dispense different product with the one equipment at the same time
- Equipped with n. 2 I-Tank insulated tanks of 5 litres each.

GT PUSH, 2 INSULATED BOWLS AND ELECTRONICAL CONTROL

Electric

Supply voltage:	220-240 V / 1 ph / 50 Hz
Electrical power max.:	0.63 kW
Current consumption:	3.8 Amps
Plug type:	CE-SCHUKO

Key Information:

Number of bowls:	2
Bowl's capacity:	5 lt
Control board:	Mechanical
Dimensions, Width:	450 mm
Dimensions, Depth:	435 mm
Dimensions, Height:	650 mm
Net weight:	46 kg
Cooling system:	AIR

Refrigeration Data

Refrigerant gas:	R290
Sustainability	
Current consumption:	3.8 Amps

Certifications



The company reserves the right to make modifications to the products without prior notice. All information correct at time of printing.

2026.04.21

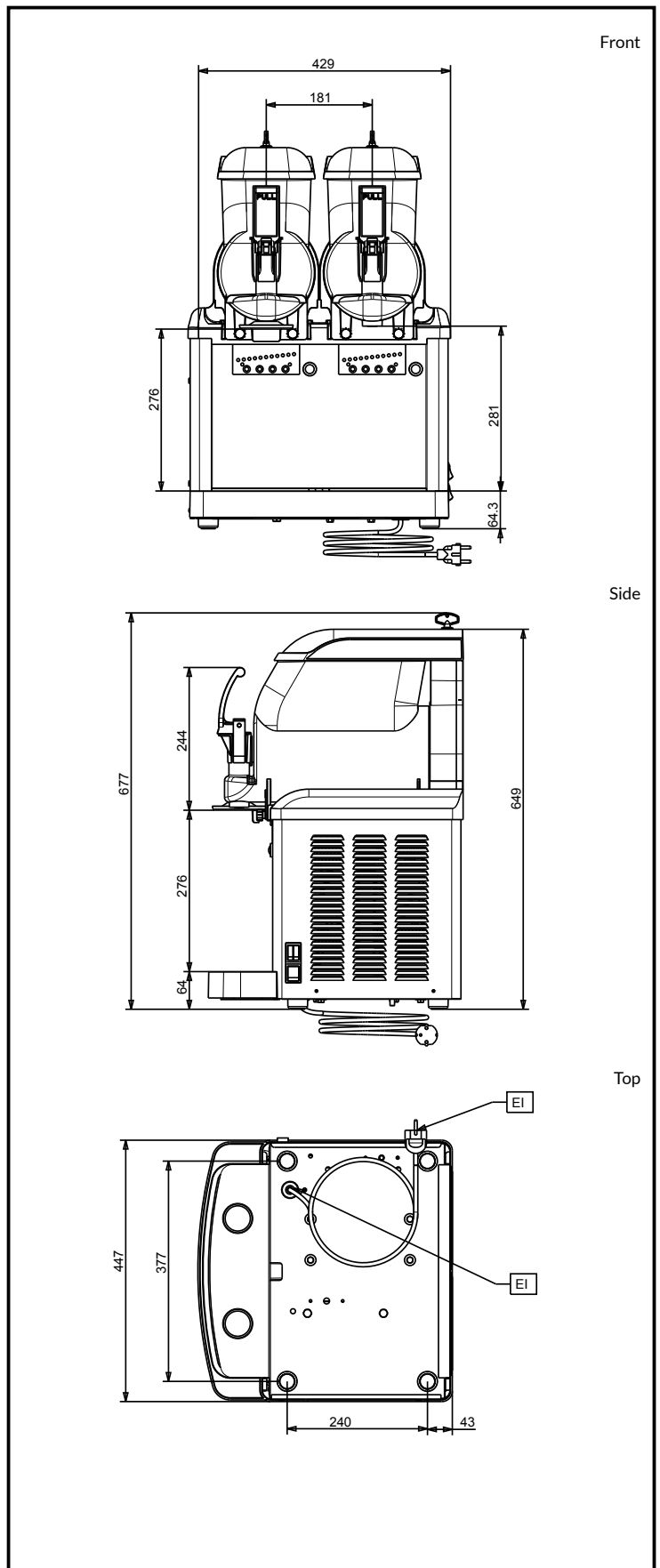

SPM

www.spm.drink-systems.com
infospm@electroluxprofessional.com